



www.perma-cool.com

Installation Instructions

This guide covers the following Item:

Custom Fit Applications

Congratulations, you have made a wise decision. Thank you for purchasing our product.

Custom Fit Oil Filter Relocation System

IMPORTANT! READ ALL INSTRUCTIONS BEFORE BEGINNING INSTALLATION.

With the engine cold, remove the old oil filter. Clean the sealing surface. Install the two hose fittings in the engine adapter. Seal the threads with Teflon® tape or appropriate sealer. **MAXIMUM** torque on the fittings is 28 ft. lbs. (38 Nm). **DO NOT OVER-TIGHTEN.** (Illustration A).

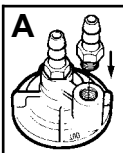

To install the engine adapter, apply a thin film of oil to the engine adapter O-Ring. Install the adapter in place of the oil filter. Tighten by hand 1/2 turn past contact with the sealing surface. Note: An O-Ring **MUST** be used between the adapter and the engine.

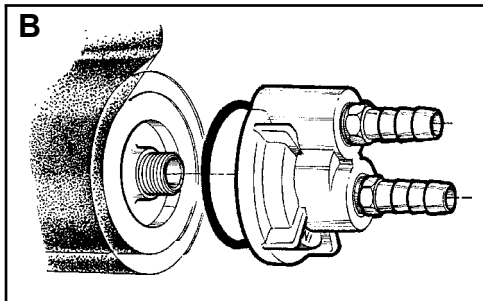

Install the threaded nipple into the bottom of the remote oil filter mount. Insert the shortest end in the mount and tighten securely. Repeat for dual mount, if applicable. (Illustration C). **DO NOT** use Teflon® tape on filter nipple.

Install the two hose fittings in the filter mount. Use the same procedure as step 2. (Illustration D). **DUAL REMOTE FILTER SYSTEM:** The dual filter mount has two ports for the flow of oil in and out of the filters. Select the most convenient port with the arrow pointed **IN** toward the center of casting. Install a hose fitting. Install a plug in the other **IN** port. Select the most convenient port with the arrow pointed **OUT** from the casting. Install a hose fitting. Install a plug in the other **OUT** port. Use Teflon® tape, as above (Illustration G).

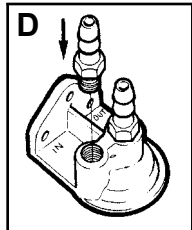
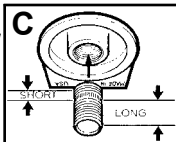

Uncoil the hose to its full length and measure. The maximum distance the mount can be installed is one half the distance of the hose length. Select a location and install the remote oil filter mount. Mark and drill the mounting holes. Attach mount using the fasteners supplied. Consider the following when choosing a location; the combined weight of the mount and full oil filter(s) and a clearance of 1" (25mm) minimum in all directions around the filter canister. (Illustration E).

Slide two (2) loose hose clamps over the end of the hose. Push the hose over the "OUT" fitting on the engine adapter. Position and fit the hose to deliver engine oil to the remote oil filter mount "IN" fitting. Keep the hose away from hot surfaces and sharp edges. Do not bend the hose sharper than a five inch radius. Rough cut the hose with at least 1 inch (25mm) longer than needed. Push hose end over the "IN" fitting on the filter mount. (Illustration F).

Slide two (2) loose hose clamps over the end of remaining hose. Complete the circuit by adding the remaining hose connecting the "IN" fitting on the engine adapter to the remote oil filter mount "OUT" fitting. (Illustration G).

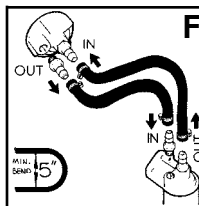
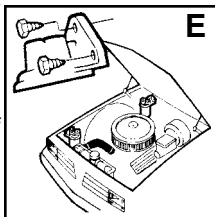

Position the clamps 1/8" (3mm) from the end of the hose, and tighten. The proper tension is indicated by the hose surface bulging slightly up through the slots in the clamps. The hose should not rip or burst through the slots (Illustration H). **CAUTION:** Avoid hot exhaust pipes, manifolds, or headers. **DO NOT BEND** the hose sharper than a 5 inch radius. Secure hoses with clamps or tie-straps if necessary.

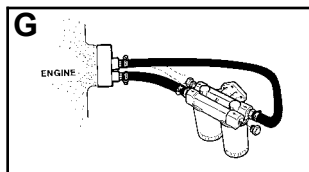

Install a new full flow oil filter(s) on the remote filter mount. All oil filter mounts in these systems utilize a Ford type oil filter. Use the chart below to determine which oil filter to purchase. Lubricate the oil filter gasket with new motor oil and hand turn 1/2 turn after gasket contacts the sealing surface. It is recommended that all oil filter(s) be filled with new oil **BEFORE** installation. When installation is completed, test as follows **BEFORE DRIVING VEHICLE ON THE STREET:**

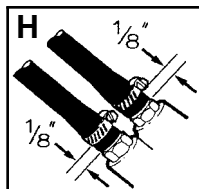

A. Recheck all fittings, adapters, clamps, and hose for proper tension and safe routing.
B. Set parking brake. Place transmission in "PARK" or "NEUTRAL". Start engine and immediately check oil pressure.
C. Check for leaks at adapters, fittings, hose and clamps. If leaks are observed, **STOP MOTOR IMMEDIATELY!!!**
D. Idle motor for 10 minutes. Continue to check for leaks.
E. Stop engine. Check oil level with dipstick. Add oil if necessary. **DO NOT OVERFILL!**

Operate vehicle in normal manner for a day or so. **RECHECK** all hose clamps for proper tension. Retighten if necessary.

GENERAL INFORMATION: Check hoses every six months for tears, collapsed or pinched sections. The hose should be replaced every two years. Hoses should be positioned to provide easy drain off during oil changes.

Note: Some vehicles have extra long oil filter nipples. For these models it may be necessary to cut the nipple at about 5/8" (16mm) from the face of the filter landing. File and remove all chips.

Brand Name	Standard Fit	Tight Fit
PERMA-COOL®	81008	81043
AC®	PF2	PF13
FRAM®	PH8A	PH43
LEE®	LF1	LF16
MOTORCRAFT®	FL1A	FL173A
NAPA®	1515	1068
PUROLATOR®	L30001	L14670
WIX®	51515	51068

For additional accessories or replacement parts
visit www.perma-cool.com